

TRIODE ELECTRONICS

A-470-S

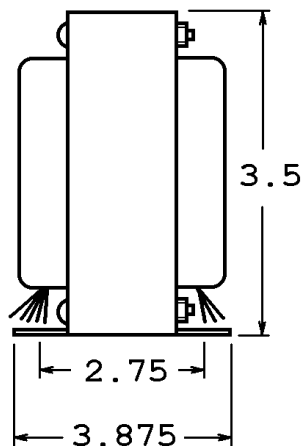

4300 OHMS CT

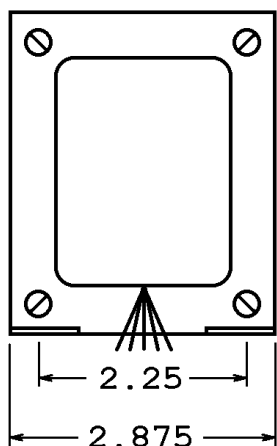
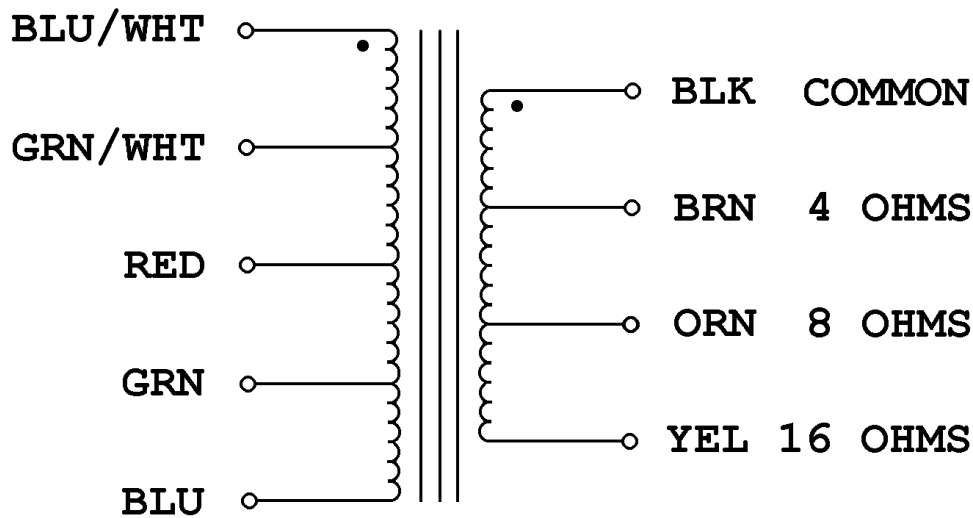

35 WATTS